



**Bailey
Morris
Limited**



***CAR, 4 x 4, LCV Propshaft
& Service Parts***

Tel: 0044 (0) 1480 216250 • Fax: 0044 (0) 1480 403045

Email: sales@baileymorris.co.uk • www.baileymorris.co.uk

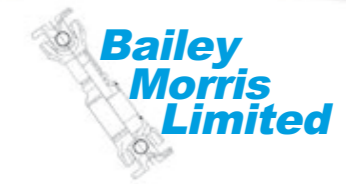

CAR AND 4X4

Vehicle	Part	Part Number	OE Part Number	Key Measurements
---------	------	-------------	----------------	------------------

Audi

Audi A8	Centre Support Bearing	BMCB221	4D0-521-113	D=30mm E=130mm
Audi Quattro	Centre Support Bearing	BMCB214	8A0-521-113A	D=30mm E=133.4mm
Audi A4	Centre Support Bearing	BMCB222	8D0-521-113A	D=30mm E=153mm
Audi A4	Centre Support Bearing	BMCB223	8D0-521-113	D=30mm E=153mm
Audi Q7	Centre Support Bearing	BMCB234		D=30mm E=154mm
Audi Q7	Centre Support Bearing	BMCB234A		D=30mm E=154mm
Audi Quattro	Centre Support Bearing	BMCB152	4A0-521-113A	D=30mm E=177.8mm
Audi A6	Centre Support Bearing	BMCB660	4B0-521-113	D=30mm E=241mm
Audi Quattro E=230/277mm	Centre Support Bearing	BMCB263		D=30mm
Audi Quattro	Centre Support Bearing	BMCB247		D=30mm E=227mm
Audi Quattro	Centre Support Bearing	BMCB249		D=30mm E=238mm
Audi Q7	Full Propshaft	AUDI/5	7L85211052L (G,C)	L=1455mm
Audi Q7	Full Propshaft	VOLKSWAGEN/1	7L6521102R	L=1246.4mm
Audi Q7	Full Propshaft	VOLKSWAGEN/4	7L6521102Q	L=1185.2mm

Daihatsu

Daihatsu	Universal Joint	BM11	04371-87501	A=20.02mm B=54.8mm
Daihatsu	Universal Joint	BM27	04371-87503	A=22.5mm C=35.2mm
Daihatsu	Universal Joint	BM40	4123-4120	A=25mm B=63.8mm
Daihatsu	Universal Joint	BM63	04371-87101	A=28.01mm B=80mm
Daihatsu	Universal Joint	BM215	04371-87304	A=30mm C=55.1mm
Daihatsu Piaggio	Full Propshaft	DAIHATSU/2	615338	L=497mm
Daihatsu Piaggio	Full Propshaft	DAIHATSU/3	615340	L=625mm
Daihatsu Piaggio	Full Propshaft	DAIHATSU/4	615339	L=515mm
Daihatsu Piaggio	Full Propshaft	DAIHATSU/5	615341	L=640mm
Daihatsu Piaggio	Full Propshaft	DAIHATSU/6	AG11-0004112	L=924.5mm
Daihatsu Piaggio	Full Propshaft	DAIHATSU/7	615344	L=445.5mm
Daihatsu Piaggio	Full Propshaft	DAIHATSU/8	37110-87Z23-A	L=670mm

Fiat

Fiat Panda	Centre Support Bearing	BMCB217		D=30mm E=138mm
Fiat Panda	Centre Support Bearing	BMCB237	46407936	D=25mm E=133mm
Fiat Panda	Full Propshaft	FIATPANDA-1	55222107	L=1740mm



“Committed to providing a top quality, highly flexible manufacturing facility”

Overview

Established in 1977, Bailey Morris Ltd is the U.K.'s foremost specialist propshaft company. With facilities in both Cambridgeshire and West London (Feltham), we can ensure that our extensive stock provides the widest choice of leading brand products sourced from the world's foremost original equipment component manufacturers. We endeavour to provide our clients with a swift, efficient, flexible and cost effective solution for any propshaft application. Bailey Morris Ltd has built its reputation for exceeding customer expectations; achieved by using a combination of high quality parts, controlled manufacturing standards and considerable product knowledge. As a specialist manufacturer we provide a service for a diverse range of applications including automotive, commercial, off-highway and industrial applications. As part of our technical service we offer guidance on appropriate shaft recommendations, safe operating speeds and anticipated life-expectancy calculations.

Propshaft Manufacturing Specialists

We provide a wide range of propeller shafts for specialist requirements such as vintage, classic and kit car applications, 4x4 vehicles, P.T.O (power take-off) shafts, engine test cell applications, marine and industrial installations. This compliments our core business of propshafts for LCV, HGV, PSV and off-highway construction vehicles. We take pride in providing the most appropriate solution to meet your requirements.

Our flexible capacity means we can offer a complete range of services for the assembly of standard and custom-built propshafts, new or remanufactured propshafts, repairs, modifications and upgrades – all of this for both original equipment and aftermarket options. Whatever the application or customer specification, our facility can cater for small, medium or large scheduled production, prototype manufacture or single orders for a wide range of propshafts.

Bailey Morris Ltd endeavours to provide an 'All-Makes' propshaft and components programme covering popular vehicle marques such as:

**Benford
BMC
Caterpillar
Chrysler
DAF / Leyland
ERF
Foden
Ford
Honda**

**Hyundai
Iveco
JCB
Land Rover
MAN
Mercedes-Benz
Mitsubishi
Nissan
Plasser Theurer**

**Renault
Scania
Terex
Toyota
Triumph
Unimog
Vauxhall
Volkswagen
Volvo**

Popular items are often available from stock on either a new or service exchange basis. With our comprehensive facility for preparation, assembly, welding, straightening, dynamic balancing and finishing of propshafts, we are able to offer the complete service for any propshaft requirement.

**Little End Road
Eaton Socon
St Neots
Huntingdon
Cambridgeshire
PE19 8GE**

**Tel: 0044 (0) 1480 216250
Fax: 0044 (0) 1480 403045**

**Email: sales@baileymorris.co.uk
www.baileymorris.co.uk**



Ford

Ford Ranger	Universal Joint	BM681	1772724	A=27mm	B=92.1mm
Ford Ranger	Centre Support Bearing	BMCB205	1512772	D=28mm	E=181mm
Ford Ranger	Centre Support Bearing	BMCB149		D=30mm	E=149mm
Ford Ranger	Centre Support Bearing	BMCB260	5031497	D=35mm	E=180mm
Ford Ranger	Centre Support Bearing	BMCB260A	5031497	D=35mm	E=180mm
Ford Ranger	Centre Support Bearing	BMCB266	SA12-25-300	D=35mm	E=163mm
Ford Ranger	Full Propshaft	RANGER	5238525	L=1600mm	
Ford Ranger	Full Propshaft	RANGER/1	3636418		
Ford Ranger	Full Propshaft	RANGER/2	4067082		
Ford Ranger	Full Propshaft	RANGER/3	5223453	L=1445mm	
Ford Ranger	Full Propshaft	RANGER/4		L=660mm	
Ford Ranger	Full Propshaft	RANGER/6	AB39-4K145-AF	L=1599.9	
Ford Explorer	CV Joint Assembly	BMCV18	231106WAB1673		
Ford Explorer	CV Joint Assembly	BMCV24			
Ford Explorer	Full Propshaft	EXPLORER	XL24-4A376-BA	L=705mm	
Ford Explorer	Full Propshaft	EXPLORER/1		L=782mm	

Isuzu

Isuzu	Universal Joint	BM425	9-44135-224-0	A=20.5mm	B=56.6mm
Isuzu	Universal Joint	BM341		A=22.06mm	B=61.2mm
Isuzu	Universal Joint	BM69	8-97942846-1	A=29mm	C=50mm
Isuzu	Universal Joint	BM488	8-97942846-1	A=29mm	C=50mm
Isuzu	Universal Joint	BM524	8-97945102-0	A=29mm	C=69mm
Isuzu	Universal Joint	BM670	8-94376-373-0	A=33mm	B=93mm
Isuzu	Universal Joint	BM737	1-37300-047-0	A=40mm	B=115mm
Isuzu TFR	Centre Support Bearing	BMCB125	8-94328-800-0	D=30mm	E=94mm
Isuzu NPR	Centre Support Bearing	BMCB124	5-37510-007-0	D=40mm	E=157.4mm
Isuzu	Centre Support Bearing	BMCB132	8-97131143-1	D=45mm	E=158mm

Jaguar

Jaguar X400	Centre Support Bearing	BMCB12	EBC9040	D=30mm	E=76mm
Jaguar XJ350	Centre Support Bearing	BMCB157		D=30mm	E=170mm
Jaguar X400	Centre Support Bearing	BMCB236		D=65mm	E=170mm

Jeep Cherokee

Jeep Cherokee	Universal Joint	BM18		A=22mm	B=57.5mm
Jeep Cherokee	Universal Joint	BM415	4137757	A=30.15mm	C=52.45mm
Jeep Cherokee	CV Joint Assembly	BMCV21			
Jeep Cherokee	CV Joint Assembly	BMCV21/1			
Jeep Cherokee	CV Joint Assembly	BMCV21/2			
Jeep Cherokee	CV Joint Assembly	BMCV22			
Jeep Cherokee	CV Joint Assembly	BMCV34			
Jeep Cherokee	CV Joint Assembly	BMCV39			
Jeep Cherokee	CV Joint Assembly	BMCV58	52853027AA		
Jeep Cherokee	Full Propshaft	CHEROKEE/1	53005544AB	L=698mm	
Jeep Cherokee	Full Propshaft	CHEROKEE/2	53005545AB	L=727mm	
Jeep Cherokee	Full Propshaft	CHEROKEE/3	53005542AB	L=771mm	
Jeep Cherokee	Full Propshaft	CHEROKEE/4	56022389AA	L=803mm	
Jeep Cherokee	Full Propshaft	CHEROKEE/5	52099497AE	L=830mm	
Jeep Cherokee	Full Propshaft	CHEROKEE/6	52099499AG	L=840mm	
Jeep Cherokee	Full Propshaft	CHEROKEE/9	52099498AE	L=791mm	
Jeep Cherokee	Full Propshaft	CHEROKEE/11	52098866	L=808mm	
Jeep Cherokee	Full Propshaft	CHEROKEE/12	53005541AB	L=643mm	
Jeep Cherokee	Full Propshaft	CHEROKEE/13	52111594AA	L=709.3mm	
Jeep Cherokee	Full Propshaft	CHEROKEE/14	52111591AB	L=731.3mm	
Jeep Cherokee	Full Propshaft	CHEROKEE/15	52111596AA	L=764.3mm	
Jeep Cherokee	Full Propshaft	CHEROKEE/16	52111593AA	L=792mm	
Jeep Cherokee	Full Propshaft	CHEROKEE/17	52853027AA	L=856.2mm	
Jeep Cherokee	Full Propshaft	CHEROKEE/18	52853417AD	L=790.4mm	
Jeep Cherokee	Full Propshaft	CHEROKEE/19	52853299AB		

Honda

Honda	Universal Joint	BM453	44330-538004	A=22mm	B=65mm
Honda	Universal Joint	BM305	40150-567003	A=25mm	B=64mm
Honda	Universal Joint	BM40	40150-56703	A=25mm	B=63.8mm
Honda	Centre Support Bearing	BMCB264	40520-S10-000	D=25mm	E=170mm
Honda	Centre Support Bearing	BMCB265	40100-S9A-J01	D=25mm	E=160mm
Honda CRV	Full Propshaft	HONDA-3	40100-S10-A01	L=2107mm	
Honda CRV	Full Propshaft	HONDA-5	40100-S9A-E01	L=2060mm	
Honda CRV	Full Propshaft	HONDA-6	40100-SKNE0	L=2065mm	
Honda CRV	Full Propshaft	HONDA-7	40100-SWY-E011-M1		

Hyundai

Hyundai	Universal Joint	BM215		A=30mm	C=55.1mm
Hyundai	Universal Joint	BM422	49140-43001	A=27mm	B=80mm
Hyundai	Universal Joint	BM49		A=27mm	B=61.9mm
Hyundai Santa Fe	Centre Support Bearing	BMCB127	MR165252	D=30mm	E=160mm
Hyundai Santa Fe	Centre Support Bearing	BMCB274		D=30mm	E=180mm
Hyundai Santa Fe	Centre Support Bearing	BMCB283	49575-2E000	D=30mm	E=180mm





Kia

Kia	Universal Joint	BM48		A=26.5mm	C=48mm
Kia	Universal Joint	BM518		A=32mm	C=57mm
Kia	Universal Joint	BM793		A=28mm	C=48.4mm
Kia Sorrento	Centre Support Bearing	BMCB167		D=28mm	E=168mm
Kia Sorrento	Centre Support Bearing	BMCB218		D=30mm	E=171.4mm
Kia Sorrento	Full Propshaft	KIA-3	49100-3E100	L=660mm	
Kia Sorrento	Full Propshaft	KIA-4	49100-3E150	L=655mm	
Kia Sorrento	Full Propshaft	KIA-6	49100-3E000	L=655mm	
Kia Sorrento	Full Propshaft	KIA-7	49100-3E050	L=646mm	
Kia Sorrento	Full Propshaft	KIA-10	49100-3E110	L=675mm	
Kia Sorrento	Full Propshaft	KIA-11	49100-3E420	L=640mm	
Kia Sorrento	Full Propshaft	KIA-12	49100-3E300	L=1100mm	
Kia Sportage	Centre Support Bearing	BMCB276		D=28mm	E=172mm
Kia Sportage	Centre Support Bearing	BMCB278		D=25mm	E=165mm
Kia Sportage	Full Propshaft	KIA-1	OK018-25-100	L=1117mm	
Kia Sportage	Full Propshaft	KIA-2	OK011-25-100	L=758mm	
Kia Sportage	Full Propshaft	KIA-8	49300-3W000	L=1990mm	
Kia Sportage	Full Propshaft	KIA-9	49300-2E000	L=1975mm	

Landrover

ILandrover	Universal Joint	BM195	RTC3458	A=27mm	B=74.6mm
Landrover	Universal Joint	BM52/1	RTC4587	A=27mm	B=74.6mm
Landrover	Universal Joint	BM54		A=27mm	B=74.6mm
Landrover	Universal Joint	BM297		A=27mm	B=74.6mm
Landrover	Universal Joint	BM669	STC4807	A=27mm	B=92.1mm
Landrover	Universal Joint	BM59	STC4807	A=27mm	B=92.1mm
Landrover	Universal Joint	BM800		A=27mm	B=92.1mm
Landrover	Full Propshaft	553000	553000	L=610mm	
Landrover	Full Propshaft	FRC6243	FRC6243	L=610mm	
Landrover	Full Propshaft	571955	571955		
Landrover	Full Propshaft	FRC4799	FRC4799		
Landrover	Full Propshaft	591278	591278		
Landrover	Full Propshaft	594361	594361		
Landrover	Full Propshaft	LR010465	LR010465	L=675mm	
Landrover Defender	Full Propshaft	FRC8386	FRC8386	L=604mm	
Landrover Defender	Full Propshaft	FRC8390	FRC8390	L=650mm	
Landrover Defender	Full Propshaft	TVB100610	TVB100610	L=604mm	
Landrover Defender	Full Propshaft	FRC8392	FRC8392	L=640mm	
Landrover Discovery	Centre Support Bearing	BMCB184		D=30mm	E=130mm
Landrover Discovery	Centre Support Bearing	BMCB184A		D=30mm	E=130mm
Landrover Discovery	Full Propshaft	33AS-4	FRC8386	L=604mm	
Landrover Discovery	Full Propshaft	33AS-7B	TVB000100	L=604mm	
Landrover Discovery	Full Propshaft	TVB500360	TVB500360	L=1309.3mm	
Landrover Discovery	Full Propshaft	TVB500360A	TVB500360	L=1309.3mm	
Landrover Discovery	Full Propshaft	TVB500510A	TVB500510		
Landrover Discovery	Full Propshaft	FRC4907	FRC4907	L=530mm	
Landrover Discovery	Full Propshaft	FRC5566	FRC5566	L=650mm	
Landrover Discovery	Full Propshaft	FRC8390	FRC8390	L=650mm	
Landrover Discovery	Full Propshaft	FRC8392	FRC8392	L=640mm	
Landrover Discovery	Full Propshaft	FTC3245	FTC3245	L=1018mm	
Landrover Discovery	Full Propshaft	FTC3905	FTC3905	L=1066mm	
Landrover Discovery	Full Propshaft	STC121	STC121	L=580mm	
Landrover Discovery	Full Propshaft	TVB100610	TVB100610	L=604mm	
Landrover Freelander	Centre Support Bearing	BMCB96	TOQ000040	D=30mm	E=138mm
Landrover Freelander	Centre Support Bearing	BMCB96/1	TOQ000040	D=30mm	E=138mm
Landrover Freelander	Centre Support Bearing	BMCB96/2	TOQ000060	D=30mm	E=138mm
Landrover Freelander	Full Propshaft	14D-1	TVB000170		
Landrover Freelander	Full Propshaft	14D-2	TVB000090	L=814.9mm	
Landrover Freelander	Full Propshaft	14D-2A	TVB000090	L=814.9mm	
Landrover Freelander	Full Propshaft	14D-6	TVB000190	L=880mm	
Landrover Freelander	Full Propshaft	UL9U010	UL9U010		
Landrover Freelander	Full Propshaft	LR006959	LR006959		

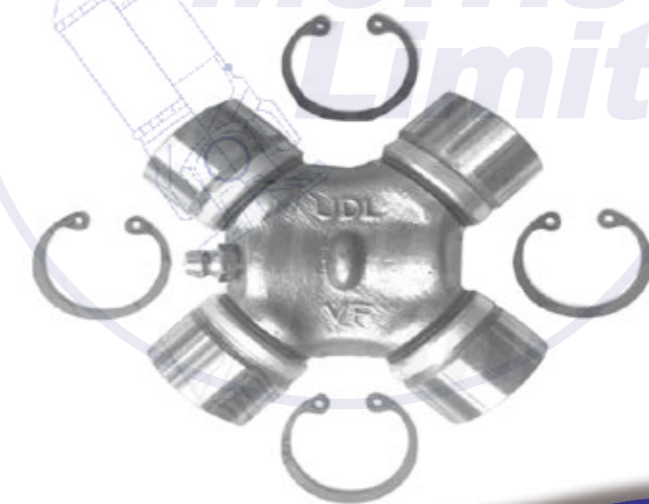
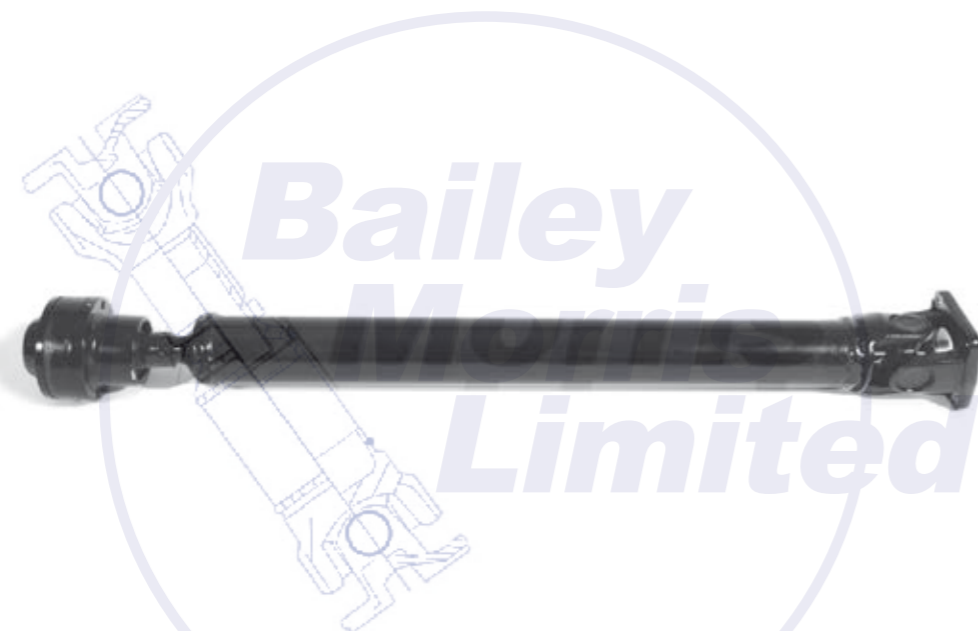



Lexus

Lexus	Centre Support Bearing	BMCB245	37230-29015	D=30mm	E=173.5mm
Lexus	Centre Support Bearing	BMCB246	37230-49015	D=30mm	E=165mm

LTC London Taxi

LTC London Taxi	CV Joint Assembly	BMCV06			
LTC London Taxi	CV Joint Assembly	BMCV43	61002041C		
LTC London Taxi	Centre Support Bearing	BMCB216	4480220	D=30mm	E=138mm

Mazda

Mazda	Universal Joint	BM11	0180-89-251	A=20.02mm	B=54.8mm
Mazda	Universal Joint	BM27	3919-89-251	A=22.5mm	C=35.2mm
Mazda	Universal Joint	BM38	M090-89-251	A=25mm	C=41.2mm
Mazda	Universal Joint	BM40		A=25mm	B=63.8mm
Mazda	Universal Joint	BM48	N090-89-251	A=26.5mm	C=48mm
Mazda	Universal Joint	BM60	0706-89-251	A=28mm	C=56mm
Mazda	Universal Joint	BM304		A=27.38mm	C=50.8mm
Mazda	Universal Joint	BM341		A=22.06mm	B=61.2mm
Mazda	Universal Joint	BM518	0164-89-251	A=32mm	C=57mm
Mazda	Universal Joint	BM601		A=37mm	C=66.8mm
Mazda	Universal Joint	BM629		A=24.06mm	B=71.4mm
Mazda	Centre Support Bearing	BMCB146	P030-25-310	D=25mm	E=163mm
Mazda	Centre Support Bearing	BMCB149		D=30mm	E=149mm
Mazda	Centre Support Bearing	BMCB156		D=28mm	E=164mm
Mazda	Centre Support Bearing	BMCB205		D=28mm	E=181mm
Mazda	Centre Support Bearing	BMCB260	SA68-25-300A	D=35mm	E=180mm
Mazda	Centre Support Bearing	BMCB260A	SA68-25-300A	D=35mm	E=180mm

Mercedes

Mercedes	Centre Support Bearing	BMCB171	1234101081	D=30mm	E=131mm
Mercedes	Centre Support Bearing	BMCB172	1244100181	D=25mm	E=118mm
Mercedes	Centre Support Bearing	BMCB174	1264100181	D=30mm	E=120mm
Mercedes	Centre Support Bearing	BMCB175	1154104481	D=30mm	E=125mm
Mercedes	Centre Support Bearing	BMCB210	1294100381	D=30mm	E=126mm
Mercedes	Centre Support Bearing	BMCB253	2104101881	D=25mm	E=208mm
Mercedes E190	Centre Support Bearing	BMCB207	2014100581	D=25mm	E=111mm
Mercedes E300	Centre Support Bearing	BMCB203	2104101681	D=30mm	E=208mm
Mercedes ML270	Centre Support Bearing	BMCB113	1634100010	D=30mm	E=100mm
Mercedes ML270	Centre Support Bearing	BMCB113A	1634100010	D=30mm	E=100mm
Mercedes ML270	CV Joint Assembly	BMCV30			
Mercedes ML270	Full Propshaft	ML-270	1634100301	L=766mm	
Mercedes ML270	Full Propshaft	ML-270/1	1634100402		
Mercedes ML270	Full Propshaft	ML-270/2	1634100201	L=696mm	
Mercedes ML270	Full Propshaft	ML-270/3	1634100901	L=717mm	
Mercedes ML270	Full Propshaft	ML-270/4	1634100101	L=571mm	
Mercedes ML270	Full Propshaft	ML-270/5	1634101202		
Mercedes ML270	Full Propshaft	ML-270/6	1634100702		
Mercedes ML270	Full Propshaft	ML-270/7	1634100802	L=1275mm	

Mitsubishi

Mitsubishi	Universal Joint	BM11	MB505372	A=20.02mm	B=54.8mm
Mitsubishi	Universal Joint	BM560		A=22.06mm	B=64.5mm
Mitsubishi	Universal Joint	BM511		A=25.01mm	B=77.8mm
Mitsubishi	Universal Joint	BM39	MB154485	A=25mm	B=76.8mm
Mitsubishi	Universal Joint	BM40	MT372505	A=25mm	B=63.8mm
Mitsubishi	Universal Joint	BM512		A=26mm	B=68mm
Mitsubishi	Universal Joint	BM56		A=27mm	B=65.3mm
Mitsubishi	Universal Joint	BM50		A=27mm	B=81.8mm
Mitsubishi	Universal Joint	BM50/3		A=27mm	B=81.8mm
Mitsubishi	Universal Joint	BM739		A=28mm	C=49mm
Mitsubishi	Universal Joint	BM215	MR232151	A=30mm	B=55.1mm
Mitsubishi	Universal Joint	BM261	MR377128	A=30mm	C=71mm
Mitsubishi	Universal Joint	BM499		A=30.2mm	B=106.3mm
Mitsubishi	Universal Joint	BM342		A=28mm	C=56mm
Mitsubishi	Universal Joint	BM811		A=38mm	B=104mm
Mitsubishi	Universal Joint	BM517	MC999303	A=44mm	B=129mm
Mitsubishi	Centre Support Bearing	BMCB148	MB505495	D=30mm	E=190mm
Mitsubishi	Centre Support Bearing	BMCB140		D=30mm	E=162mm
Mitsubishi Galloper	Full Propshaft	MITSUBISHI-1	HB101000	L=843mm	
Mitsubishi Galloper	Full Propshaft	MITSUBISHI-2	49020M1210	L=776mm	
Mitsubishi L200	Centre Support Bearing	BMCB229	MR223119	D=30mm	E=159mm
Mitsubishi L200	Centre Support Bearing	BMCB233	MR580647	D=30mm	E=160mm
Mitsubishi L200	Centre Support Bearing	BMCB112	MR305905	D=30mm	E=163mm
Mitsubishi L200	Full Propshaft	MITSUBISHI-8	MB154227	L=747mm	
Mitsubishi L200	Full Propshaft	MITSUBISHI-9	MR980181	L=658mm	
Mitsubishi Shogun	Full Propshaft	MITSUBISHI-7	MR389334		

Nissan

Nissan	Universal Joint	BM12		A=22.07mm	B=52.4mm
Nissan	Universal Joint	BM17/1	37130-18000	A=20.01mm	C=35mm
Nissan	Universal Joint	BM341		A=22.06mm	B=61.2mm
Nissan	Universal Joint	BM47		A=22mm	C=37.3mm
Nissan	Universal Joint	BM449		A=24mm	B=64.2mm
Nissan	Universal Joint	BM42	37130-14601	A=25mm	C=40mm
Nissan	Universal Joint	BM490	37125-J2027	A=25mm	C=52mm
Nissan	Universal Joint	BM344	39126-01G25	A=27mm	C=46.1mm
Nissan	Universal Joint	BM55		A=27mm	B=81.8mm
Nissan	Universal Joint	BM432	6232-43000	A=28mm	C=56mm
Nissan	Universal Joint	BM61	6232-43000	A=28mm	C=53mm
Nissan	Universal Joint	BM73	37126-85460	A=30.2mm	B=92.1mm
Nissan	Universal Joint	BM359	37125-EB51A	A=32mm	C=64mm
Nissan	Universal Joint	BM514	37125-50000	A=32mm	B=107mm
Nissan	Universal Joint	BM515	37125-Z9029	A=35.5mm	B=119.2mm
Nissan	Centre Support Bearing	BMCB141	37521-W1025	D=30mm	
Nissan D21	Centre Support Bearing	BMCB137	37521-57G26	D=30mm	
Nissan D21	Centre Support Bearing	BMCB138	37521-33G25	D=30mm	
Nissan D21	Centre Support Bearing	BMCB145	37521-W1625	D=30mm	
Nissan Navara	Full Propshaft	31AS-19	37200-0W700	L=620mm	
Nissan Navara	Full Propshaft	NISSAN-25	37300-3X32A	L=1522.9mm	
Nissan Navara	Full Propshaft	NISSAN-AS/8	37200-EB300	L=792mm	
Nissan Serena	Full Propshaft	NISSAN-1	37000-9C503	L=735mm	
Nissan Serena	Full Propshaft	NISSAN-2	37000-7C003	L=640mm	
Nissan Serena	Full Propshaft	NISSAN-4	37000-7C001	L=673.5mm	
Nissan Serena	Full Propshaft	NISSAN-5	37000-7C002	L=770mm	
Nissan Terrano	Full Propshaft	NISSAN-7		L=945mm	
Nissan Terrano	Full Propshaft	NISSAN-9		L=725mm	
Nissan Terrano	Full Propshaft	NISSAN-AS/3	37000-0F000	L=616mm	
Nissan X-Trail	Full Propshaft	NISSAN-AS/1	37000-8H310	L=2035mm	
Nissan X-Trail	Full Propshaft	NISSAN-AS/1A	37000-8H310	L=2035mm	
Nissan X-Trail	Full Propshaft	NISSAN-AS/10	37000-JG70B	L=1980mm	



Porsche

Porsche Cayenne	Full Propshaft	VOLKSWAGEN/1	95542102014	L=1246.4mm
Porsche Cayenne	Full Propshaft	VOLKSWAGEN/4		L=1185.2mm

Range Rover

Range Rover	Full Propshaft	TVB500510A	TVB500510	
Range Rover	Full Propshaft	RANGEROVER-2	TVB500450	L=620.6mm
Range Rover Sport	Full Propshaft	TVB500390	TVB500390	L=1150mm
Range Rover Sport	Full Propshaft	TVB500380	TVB500380	L=1280mm

Renault

Renault Kangoo	Centre Support Bearing	BMCB212		D=30mm	E=130mm
Renault Kangoo	Centre Support Bearing	BMCB212A		D=30mm	E=130mm
Renault Kangoo	Full Propshaft	RENAULT-1	8200149811	L=1977mm	
Renault Scenic	Centre Support Bearing	BMCB215		D=30mm	E=132mm
Renault Scenic	Full Propshaft	RENAULT-2A	8200058705	L=1982mm	

Mercedes

Mercedes	Centre Support Bearing	BMCB171	1234101081	D=30mm	E=131mm
Mercedes	Centre Support Bearing	BMCB172	1244100181	D=25mm	E=118mm
Mercedes	Centre Support Bearing	BMCB174	1264100181	D=30mm	E=120mm
Mercedes	Centre Support Bearing	BMCB175	1154104481	D=30mm	E=125mm
Mercedes	Centre Support Bearing	BMCB210	1294100381	D=30mm	E=126mm
Mercedes	Centre Support Bearing	BMCB253	2104101881	D=25mm	E=208mm
Mercedes E190	Centre Support Bearing	BMCB207	2014100581	D=25mm	E=111mm
Mercedes E300	Centre Support Bearing	BMCB203	2104101681	D=30mm	E=208mm
Mercedes ML270	Centre Support Bearing	BMCB113	1634100010	D=30mm	E=100mm
Mercedes ML270	Centre Support Bearing	BMCB113A	1634100010	D=30mm	E=100mm
Mercedes ML270	CV Joint Assembly	BMCV30			
Mercedes ML270	Full Propshaft	ML-270	1634100301	L=766mm	
Mercedes ML270	Full Propshaft	ML-270/1	1634100402		
Mercedes ML270	Full Propshaft	ML-270/2	1634100201	L=696mm	
Mercedes ML270	Full Propshaft	ML-270/3	1634100901	L=717mm	
Mercedes ML270	Full Propshaft	ML-270/4	1634100101	L=571mm	
Mercedes ML270	Full Propshaft	ML-270/5	1634101202		
Mercedes ML270	Full Propshaft	ML-270/6	1634100702		
Mercedes ML270	Full Propshaft	ML-270/7	1634100802	L=1275mm	

Ssangyong

Ssangyong Actyon	Centre Support Bearing	BMCB239		D=30mm	E=45mm
Ssangyong Korando	Centre Support Bearing	BMCB241		D=30mm	E=45mm
Ssangyong Kyron	Centre Support Bearing	BMCB238		D=30mm	E=45mm
Ssangyong Musso	Centre Support Bearing	BMCB243		D=30mm	E=45mm
Ssangyong Rexton	Centre Support Bearing	BMCB242		D=30mm	E=47mm
Ssangyong Rodius	Centre Support Bearing	BMCB244		D=30mm	E=160mm
Ssangyong Musso	Full Propshaft	SSANGYONG	33100-08621	L=678mm	
Ssangyong Musso	Full Propshaft	SSANGYONG-1		L=668mm	
Ssangyong Musso	Full Propshaft	SSANGYONG-2		L=685mm	
Ssangyong Musso	Full Propshaft	SSANGYONG-3	33100-05702X	L=675mm	
Ssangyong Musso	Full Propshaft	SSANGYONG-4	33100-06012X	L=655mm	
Ssangyong Musso	Full Propshaft	SSANGYONG-5	33100-06012X	L=975mm	
Ssangyong Rexton	Full Propshaft	SSANGYONG-6	33200-08B00		
Ssangyong Rexton	Full Propshaft	SSANGYONG-7	33200-08201		
Ssangyong Rexton	Full Propshaft	SSANGYONG-8	33100-08622	L=685mm	
Ssangyong Rexton	Full Propshaft	SSANGYONG-9	33200-08300	L=1250mm	

Subaru

Subaru	Universal Joint	BM473		A=25mm	C=40mm
Subaru	Universal Joint	BM61		A=28mm	C=53mm
Subaru	Centre Support Bearing	BMCB160		D=30mm	E=174mm
Subaru Impreza	Centre Support Bearing	BMCB235	27037-AK010	D=30mm	E=175mm

Suzuki

Suzuki	Universal Joint	BM17/1		A=20.01mm	C=35mm
Suzuki	Universal Joint	BM522		A=20.06mm	B=59.8mm
Suzuki	Universal Joint	BM415		A=30.15mm	C=52.45mm
Suzuki	Universal Joint	BM40	27200-83812	A=25mm	B=63.8mm
Suzuki	Universal Joint	BM305		A=25mm	B=64mm
Suzuki Samurai	Full Propshaft	SUZUKI-1	27102-84C00	L=710mm	
Suzuki Samurai	Full Propshaft	SUZUKI-2	27103-84C00	L=508mm	
Suzuki Vitara	Full Propshaft	SUZUKI-3	27102-B-60A01	L=896mm	
Suzuki Vitara	Full Propshaft	SUZUKI-4	27101-85C01	L=680mm	

Toyota

Toyota	Universal Joint	BM14	37431-10010	A=20mm	B=57mm
Toyota	Universal Joint	BM18		A=22mm	B=57.5mm
Toyota	Universal Joint	BM44	37411-20010	A=26mm	C=42mm
Toyota	Universal Joint	BM45	37411-30020	A=26mm	C=53.6mm
Toyota	Universal Joint	BM66	37411-60020	A=28.5mm	B=77.9mm
Toyota	Universal Joint	BM223	114-2501	A=28.5mm	C=49mm
Toyota	Universal Joint	BM486	114-2501	A=28.58mm	C=49.2mm
Toyota	Universal Joint	BM68	04371-60100	A=29mm	C=49mm
Toyota	Universal Joint	BM68A	04371-60100	A=29mm	C=49mm
Toyota	Universal Joint	BM213		A=29mm	C=49mm
Toyota	Universal Joint	BM340/1		A=29mm	C=49mm
Toyota	Universal Joint	BM162	04371-36034	A=32mm	C=61mm
Toyota	Universal Joint	BM84		A=34mm	B=107mm
Toyota	Universal Joint	BM516	37411-55020	A=39.98mm	B=118mm
Toyota Cressida	Centre Support Bearing	BMCB142	37230-22042	D=30mm	E=162mm
Toyota Hiace	Centre Support Bearing	BMCB97	37230-26020	D=30mm	E=150mm
Toyota Hilux	Centre Support Bearing	BMCB71	37230-35080	D=30mm	E=230mm
Toyota Hilux	Centre Support Bearing	BMCB187	37230-35130	D=30mm	E=150mm
Toyota Hilux	Centre Support Bearing	BMCB150	37230-35030	D=30mm	E=147mm
Toyota Hilux	Centre Support Bearing	BMCB143	37230-35070	D=30mm	E=148mm
Toyota Hilux	Centre Support Bearing	BMCB139	37230-35090	D=30mm	E=150mm
Toyota Hilux	Full Propshaft	HILUX-FRONT	37140-35060	L=620mm	
Toyota Hilux	Full Propshaft	HILUX-FRONT/1	37140-35071	L=620mm	
Toyota Hilux	Full Propshaft	HILUX-FRONT/2A	37120-35160		





Vauxhall

Vauxhall Antara	Centre Support Bearing	BMCB273	96624771	D=30mm	E=191mm
Vauxhall Omega	Centre Support Bearing	BMCB201	90343676	D=30mm	E=96mm
Vauxhall Omega	Centre Support Bearing	BMCB202	90470670	D=30mm	E=96mm

Volkswagen

Volkswagen Tiguan	Centre Support Bearing	BMCB250	2153124300	D=30mm	E=400mm
Volkswagen Tiguan	Centre Support Bearing	BMCB250A	2153124300	D=30mm	E=400mm
Volkswagen Tiguan	Full Propshaft	VOLKSWAGEN/5	5N0521101E	L=2160mm	
Volkswagen Touareg	Centre Support Bearing	BMCB198	1000008900022	D=30mm	E=68mm
Volkswagen Touareg	Centre Support Bearing	BMCB198A	1000008900022	D=30mm	E=68mm
Volkswagen Touareg	Full Propshaft	VOLKSWAGEN/1	7L6521102R	L=1246.4mm	
Volkswagen Touareg	Full Propshaft	VOLKSWAGEN/4	7L6521102Q	L=1185.2mm	

Volvo

Volvo V70	Centre Support Bearing	BMCB133	5115100281	D=25mm	E=75mm
Volvo XC70	Centre Support Bearing	BMCB279	5114102081	D=30mm	E=118mm
Volvo V70	Full Propshaft	VOLVO-CAR/7	9463300		
Volvo XC60	Full Propshaft	KUGA-1	31256426	L=2010mm	

LCV

Vehicle	Part	Part Number	OE Part Number	Key Measurements
---------	------	-------------	----------------	------------------

Ford

Ford Transit	Universal Joint	BM195		A=27mm B=74.6mm
Ford Transit	Universal Joint	BM195A		A=27mm B=74.6mm
Ford Transit	Universal Joint	BM404	4791941	A=30.2mm B=92.1mm
Ford Transit	Universal Joint	BM77		A=30.2mm B=81.8mm
Ford Transit	Universal Joint	BM232		A=30.2mm B=81.8mm
Ford Transit	Universal Joint	BM53		A=27mm B=71mm
Ford Transit	Universal Joint	BM550		A=27mm B=79.8mm
Ford Transit	Universal Joint	BM79		A=31.02mm C=44.1mm
Ford Transit	Universal Joint	BM21		A=22mm B=67mm
Ford Transit	Centre Support Bearing	BMCB57	7239265	D=30mm E=144mm
Ford Transit	Centre Support Bearing	BMCB61	88VB4826AA	D=30mm E=140mm
Ford Transit	Centre Support Bearing	BMCB19	6649122	D=45mm E=144mm
Ford Transit	Centre Support Bearing	BMCB195	8C114826AA	D=35mm E=144mm
Ford Transit	Full Propshaft	TRANSIT-3P/1	4114290	L=3084mm
Ford Transit	Full Propshaft	TRANSIT-3P/16	1755400	L=2317mm
Ford Transit	Full Propshaft	TRANSIT-3P/17	1485422	L=2969.1mm
Ford Transit	Full Propshaft	TRANSIT-3P/18	1440687	L=2767mm
Ford Transit	Full Propshaft	TRANSIT-3P/22	1749842	L=2798.1mm
Ford Transit	Full Propshaft	TRANSIT-3P/26	1747675	L=2553mm
Ford Transit	Full Propshaft	TRANSIT-3P/28	4078775	L=2891mm
Ford Transit	Full Propshaft	TRANSIT-3P/4	4078772	L=2635mm
Ford Transit	Full Propshaft	TRANSIT-3P/6	4393563	L=2590mm
Ford Transit	Full Propshaft	TRANSIT-3P/7	4743300	L=2838mm
Ford Transit	Full Propshaft	TRANSIT-3P/8	4521403	L=3040mm

Iveco

Iveco Daily	Universal Joint	BM605	42567376	A=27mm B=81.8mm
Iveco Daily	Universal Joint	BM55	42567376	A=27mm B=81.8mm
Iveco Daily	Universal Joint	BM247	42567376	A=27mm B=81.8mm
Iveco Daily	Universal Joint	BM300	42567376	A=27mm B=81.8mm
Iveco Daily	Universal Joint	BM179A	42535253	A=30.2mm B=106.3mm
Iveco Daily	Universal Joint	BM179	42535253	A=30.2mm B=106.3mm
Iveco Daily	Universal Joint	BM211	42535253	A=30.2mm B=106.3mm
Iveco Daily	Universal Joint	BM211A	42535253	A=30.2mm B=106.3mm
Iveco Daily	Universal Joint	BM232	42541373	A=30.2mm B=81.8mm
Iveco Daily	Universal Joint	BM412	42541373	A=30.2mm B=81.8mm
Iveco Daily	Centre Support Bearing	BMCB91	42561251	D=40mm E=168mm
Iveco Daily	Centre Support Bearing	BMCB56	4390495	D=35mm E=168mm
Iveco Daily	Centre Support Bearing	BMCB83	42530546	D=40mm E=168mm
Iveco Daily	Centre Support Bearing	BMCB17	93158202	D=40mm E=168mm
Iveco Daily	Full Propshaft	500391650	500391650	L=2280mm
Iveco Daily	Full Propshaft	504019827	504019827	L=371mm
Iveco Daily	Full Propshaft	500365695	500365695	L=2100mm
Iveco Daily	Full Propshaft	500304644	500304644	L=891mm



Mercedes

Mercedes Sprinter	Universal Joint	BM582		A=27mm	B=88mm
Mercedes Sprinter	Universal Joint	BM582A		A=27mm	B=88mm
Mercedes Sprinter	Universal Joint	BM566		A=24mm	B=88mm
Mercedes Sprinter	Universal Joint	BM566/1		A=24mm	B=88mm
Mercedes Sprinter	Universal Joint	BM78		A=31mm	B=88mm
Mercedes Sprinter	Centre Support Bearing	BMCB196	9064100281	A=47mm	B=194mm
Mercedes Sprinter	Centre Support Bearing	BMCB196A	9064100281	A=47mm	B=194mm
Mercedes Sprinter	Centre Support Bearing	BMCB197	9064101781	A=47mm	B=194mm
Mercedes Sprinter	Centre Support Bearing	BMCB268	9064100681	A=47mm	B=194mm
Mercedes Sprinter	Centre Support Bearing	BMCB269	9064100881	A=47mm	B=194mm
Mercedes Sprinter	Full Propshaft	SPRINTER-2P/13	A9064107616	L=2554mm	
Mercedes Sprinter	Full Propshaft	SPRINTER-2P/19	A9064102116	L=2843mm	
Mercedes Sprinter	Full Propshaft	SPRINTER-2P/20	A9064109906	L=2748mm	
Mercedes Sprinter	Full Propshaft	SPRINTER-2P/25	A9064100516	L=2775mm	
Mercedes Sprinter	Full Propshaft	SPRINTER-2P/26	A9064105606	L=2767mm	
Mercedes Sprinter	Full Propshaft	SPRINTER-2P/29	A9064107916	L=2560mm	
Mercedes Sprinter	Full Propshaft	SPRINTER-2P/32	A9064105806	L=2787mm	
Mercedes Sprinter	Full Propshaft	SPRINTER-2P/8	A9064100016	L=2582mm	
Mercedes Sprinter	Full Propshaft	SPRINTER-FRONT/1	A9064101501	L=921mm	
Mercedes Sprinter	Full Propshaft	SPRINTER-FRONT/3	A9064103401	L=853mm	
Mercedes Vito	Universal Joint	BM37		A=24mm	B=74.5mm
Mercedes Vito	Universal Joint	BM37/1		A=24mm	B=74.5mm
Mercedes Vito	Universal Joint	BM547		A=24mm	B=74.5mm
Mercedes Vito	Centre Support Bearing	BMCB120	6394100481	D=30mm	E=148mm
Mercedes Vito	Centre Support Bearing	BMCB120A	6394100481	D=30mm	E=148mm
Mercedes Vito	Centre Support Bearing	BMCB121	6394100681	D=30mm	E=148mm
Mercedes Vito	Centre Support Bearing	BMCB121A	6394100681	D=30mm	E=148mm
Mercedes Vito	Centre Support Bearing	BMCB270	6394107006	D=32mm	E=148mm
Mercedes Vito	Centre Support Bearing	BMCB270A	6394107006	D=32mm	E=148mm
Mercedes Vito	Full Propshaft	MB-VITO/1	A6394103006	L=2240mm	
Mercedes Vito	Full Propshaft	MB-VITO/14	A6394103406	L=2143mm	
Mercedes Vito	Full Propshaft	MB-VITO/15	A6394103106	L=2470mm	
Mercedes Vito	Full Propshaft	MB-VITO/16	A6394103506	L=2373mm	
Mercedes Vito	Full Propshaft	MB-VITO/17	A6394103206	L=2211mm	
Mercedes Vito	Full Propshaft	MB-VITO/18	A6394103306	L=2441mm	
Mercedes Vito	Full Propshaft	MB-VITO/19	A6394107006	L=2176mm	
Mercedes Vito	Full Propshaft	MB-VITO/21	A6394101516	L=2211mm	
Mercedes Vito	Full Propshaft	MB-VITO/22	A6394101716	L=2143mm	
Mercedes Vito	Full Propshaft	MB-VITO/23	A6394103606	L=2173mm	
Mercedes Vito	Full Propshaft	MB-VITO/24	A6394102016	L=2406mm	
Mercedes Vito	Full Propshaft	MB-VITO/25	A6394106806	L=2373mm	
Mercedes Vito	Full Propshaft	MB-VITO/26	A6394108506	L=2386mm	
Mercedes Vito	Full Propshaft	MB-VITO/27	A6394108406	L=2156mm	
Mercedes Vito	Full Propshaft	MB-VITO/28	A6394107506	L=1903mm	

Volkswagen

Volkswagen Crafter	Universal Joint	BM582		A=27mm	B=88mm
Volkswagen Crafter	Universal Joint	BM582A		A=27mm	B=88mm
Volkswagen Crafter	Universal Joint	BM566		A=24mm	B=88mm
Volkswagen Crafter	Universal Joint	BM566/1		A=24mm	B=88mm
Volkswagen Crafter	Universal Joint	BM78		A=31mm	B=88mm
Volkswagen Crafter	Centre Support Bearing	BMCB196	2E0598351	D=47mm	E=194mm
Volkswagen Crafter	Centre Support Bearing	BMCB196A	2E0598351	D=47mm	E=194mm
Volkswagen Crafter	Centre Support Bearing	BMCB197		D=47mm	E=194mm
Volkswagen Crafter	Centre Support Bearing	BMCB268		D=47mm	E=194mm
Volkswagen Crafter	Centre Support Bearing	BMCB269		D=47mm	E=194mm
Volkswagen Crafter	Full Propshaft	SPRINTER-2P/13	2E0521101J	L=2554mm	
Volkswagen Crafter	Full Propshaft	SPRINTER-2P/19	2E1521293	L=2843mm	
Volkswagen Crafter	Full Propshaft	SPRINTER-2P/20	2E0521293H	L=2748mm	
Volkswagen Crafter	Full Propshaft	SPRINTER-2P/29	2E05211163AA	L=2560mm	
Volkswagen Crafter	Full Propshaft	SPRINTER-2P/32	2E0521101BB	L=2787mm	
Volkswagen Crafter	Full Propshaft	SPRINTER-2P/8	2E0521293M	L=2582mm	
Volkswagen Crafter	Full Propshaft	SPRINTER-FRONT/1	2E0521099D	L=921mm	
Volkswagen Crafter	Full Propshaft	SPRINTER-FRONT/3	2E0521292A	L=853mm	

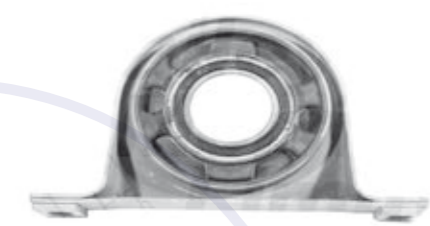
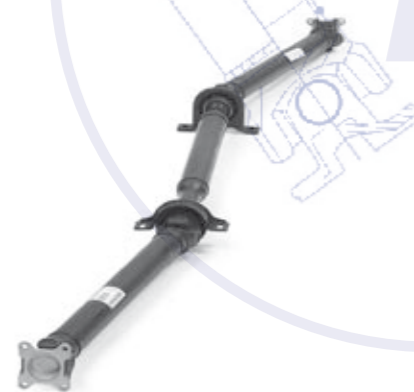



Distribution

Our comprehensive stock range enables us to provide a fast and efficient parts distribution service, covering the U.K., Europe and Worldwide. We source from all of the world's major components manufacturers, and we stock both original equipment and high-quality aftermarket products.

Our extensive inventory includes the following industry leading and widely recognised brand names; Klein, DANA Spicer, Sicit, GWB, GKN, Hardy Spicer, GMB, Matsuba, Elbe, Elso Gewes, Kempf and Tirsan Kardan. We stock a broad range of centre bearings, universal joints, flange yokes, weld yokes, slip-assemblies, splined mid-stubs, coupling flanges and propshaft specification tube. Whether your needs are for an urgent VOR (Vehicle-Off-Road) requirement, small scale ordering or for wholesale stocking purposes, our sales team can help with your individual requirements.



"We offer our clients a swift, flexible and positive response to their requirements"

"Due to the wide range of applications we are happy to offer technical support"

"Utilising road-freight, sea-freight and air-freight, we can get the parts you need to the place at which you need them."

Our Service

Parts Identification

Our service includes a parts identification program using vehicle registrations or Vehicle Identification Numbers (VIN). See below for the parts programmes available from us and feel free to call us with any kind of enquiry.



Technical Sales Support

For those questions that seem to have no answers, call our technical team at Bailey Morris. If you have an enquiry that isn't quite standard or you need some advice on, try us!

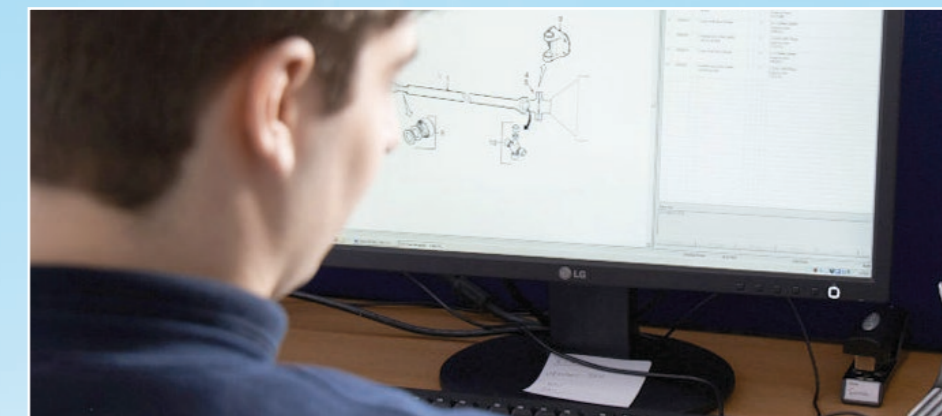

Next Day Delivery Service

At Bailey Morris, we have the ability to supply our parts on a next day service. Using a range of courier companies, we have a next day solution for almost anywhere in the UK! If you have any questions about this service then give us a call.



Identifying Universal Joint

External Circlip Universal Joint

The most commonly used universal joint which is clearly identifiable. Beware that your clips may look different but they operate in the same way.

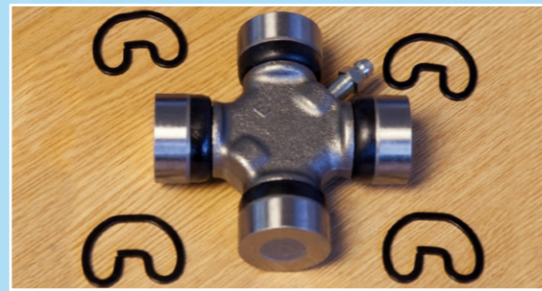

External Circlip Universal Joint Cap Diameter – Key Measurement “A”

With all universal joints, this measurement remains the same. Measure the diameter of the Universal Joint cap from edge to edge as pictured.



External Circlip Universal Joint Span – Key Measurement “B”

Ensuring that the caps are pressed on firmly, take your Vernier Caliper (or tape measure!) and measure the span from cap to cap.



Internal Circlip Universal Joint

Differing slightly from the External Circlip Universal Joint, this variety comes with “half-moon” clips that sit in the cap.



Internal Circlip Universal Joint Cap Diameter – Key Measurement “A”

The most commonly used universal joint which is clearly identifiable. Beware that your clips may look different but they operate in the same way.



Internal Circlip Universal Joint Span – Key Measurement “C”

The main difference between measuring an External Circlip Universal Joint and an Internal Circlip one is the span. The measurement needs to be taken between the circlip grooves as pictured.

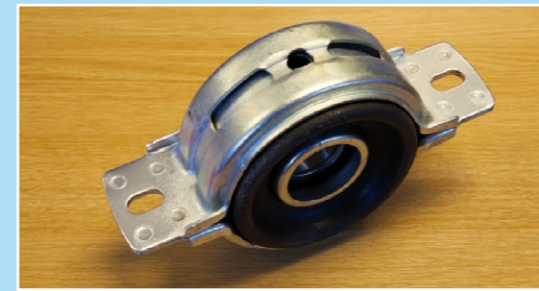

Identifying Centre Bearings

Centre Support Bearing

Note: yours may look different but the key measurements remain the same!



Centre Support Bearing Diameter – Key Measurement “D”

The first measurement you take should be the diameter of the bearing. As pictured, take the measurement of the bearing hole diameter.



Centre Support Bearing Bolt Hole Centres – Key Measurement “E”

The next measurement should be the hole centres where the bearing bolts to the vehicle. Measure from centre-to-centre or from near edge to far edge (as pictured) as accurately as you can.

“Most importantly, if you need assistance, give us a call! 01480 216250”

Sales@baileymorris.co.uk

Product Range

- From SAE 0500 series to 1900 series flanged
- Open yoke and half round design including Scania style
- DIN 58mm flange to 250mm inclusive
- (KV) cross tooth 120mm to 200m
- Mechanics 2C - 15C J800
- Japanese/Asian type shafts
- Specialist dynamometer and engine test cell shafts
- Flexible drive couplings
- Please visit www.baileymorris.co.uk for more information about our company including our general parts catalogue





Bailey Morris Limited

*Little End Road
Eaton Socon
St Neots
Huntingdon
Cambridgeshire
PE19 8GE*

*Tel: 0044 (0) 1480 216250
Fax: 0044 (0) 1480 403045*

*Email: sales@baileymorris.co.uk
www.baileymorris.co.uk*